



*Jordan XL w/convex screen
front - brushed stainless*

Jordan Series

Minneapolis Contemporary Insert	3
Rockford Contemporary Insert	4
Jordan Options & Accessories	5
Jordan Specifications	6

Chaska Series

Chaska Options & Accessories	8
Chaska Specifications	9

Jackson Series

Jackson Options & Accessories	11
Jackson Specifications	12



Jordan w/Beveled screen front



Jordan w/Rectangular screen front - rust finish



Jordan w/Rectangular screen front - Arched Prairie doors

*Minneapolis XL w/Rectangular
screen front*



*Minneapolis w/
Rectangular screen
front - titanium*



*Minneapolis w/Convex
screen front -
brushed stainless*

Rockford XL w/Convex screen front - brushed stainless



Rockford w/Rectangular screen front - titanium



Rockford w/Convex screen front - black



JORDAN SERIES OPTIONS & ACCESSORIES

Shrouds/Fronts/Doors



Rectangular screen front w/Prairie doors



Rectangular screen front w/Arched Prairie doors



Beveled screen front



Convex screen front (titanium)



Rectangular screen front (rust)



Convex screen front (brushed stainless)



Rectangular screen front (titanium)



Convex screen front

Refractory Lining



Brick refractory (standard in Jordan)



Brick refractory (standard in Jordan XL)



Black enamel panels

Glass Media



Cobalt Blue



H2O



White Frost

(Glass Media Minneapolis only)

Finishes



Titanium finish



Rust finish



Brushed stainless finish

Controls



IPI full function remote

Old fireplaces are inefficient, often have draft issues, and can pose a potential safety threat to your home – not to mention an eye sore. The *Jordan* series gas inserts combine efficiency, safety, and IPI technology that is environmentally friendly. The *Jordan*, *Minneapolis*, and *Rockford* inserts offer a louverless firebox, enormous viewing area, and realistic flame. With three models to choose from you can give your existing wood burning fireplace a new modern look, or stay with a traditional style.

JORDAN & JORDAN XL SERIES GAS INSERT SPECIFICATIONS

The Jordan Series Includes: Jordan, Minneapolis & Rockford
 The Jordan XL Series Includes: Jordan XL, Minneapolis XL & Rockford XL

Standard Features

- 32,000 btu/hr input - (NG & LP) Jordan
- 26,000 btu/hr input - (NG & LP) Minneapolis
- 26,000 btu/hr input - (NG & LP) Rockford
- 37,000 btu/hr input (NG & LP) Jordan XL
- 25,000 btu/hr input (NG & LP) Minneapolis XL
- 32,000 btu/hr input (NG & LP) Rockford XL
- High efficiency: Natural Gas - 74.16% LP Gas - 76.66%
- **Canada P-4 approved**
- Electronic ignition pilot system - standing pilot option as well
- LOG SET (Jordan & Jordan XL)
- GLASS MEDIA (Minneapolis & Minneapolis XL) - black
- ROCK SET (Rockford & Rockford XL)
- Co-linear air duct - accepts 3" combustion air / 3" exhaust
- High quality lifetime glass (29 5/8" X 21 1/2") Quick-latch removal
- Remote control - thermostatic (flame, fan & light kit adjustment)
- Top accent lighting system - XL models only
- Fan kit - (1) 75 CFM blower
- Refractory brick lining (Jordan & Jordan XL)
- Black enamel panels (Minneapolis, Minneapolis XL, Rockford & Rockford XL)
- Engineer-designed burner system
- Minnesota energy code compliant to 50 pascals

Required for Installation

- 1 piece shroud (standard size or custom size)
- Screen front* - rectangular, beveled & convex designs
- *Screen is removable.

Optional Features

- Decorative doors - Prairie and Arched Prairie
- Shroud trim
- Refractory overlay (Jordan & Jordan XL only) - black enamel panels
- Glass media (MPLS & MPLS XL only) - cobalt blue, H2O & white frost
- Floor protector - *required if removing existing floor* (see manual)

Safety

- Each unit factory tested!
- Tested by OMNI - test laboratories
- Complies with ANSI-Z21.88a -2009•CSA 2.33-2009 P.4.1-09 'Vented Gas Fireplace Heaters'
- U.S. & Canadian installation approved
- Sealed combustion chamber
- Removable control board with safety pilot
- Automatic pressure relief glass system
- Bedroom & mobile home approved

Specifications

- | | |
|------------------------|-------------------------|
| Jordan Series | Jordan XL Series |
| • Height: 19 3/4" | • Height: 23 5/8" |
| • Width: 30" | • Width: 34" |
| • Back Width: 24 5/16" | • Back Width: 28 3/16" |
| • Depth: 15 1/2" | • Depth: 16 3/8" |
| • Weight: 150 lbs. | • Weight: 165 lbs. |

Clearances

Jordan Series

- From insert to combustible floor in front Refer to chart in manual
- From insert to side wall. 3"
- Mantel 9" deep from top of insert* 12"
- *Mantel must be a minimum of 12" from top of fireplace face. The maximum depth at this height is 9". See additional mantel clearance configurations in the installation manual.

Jordan XL Series

- From insert to combustible floor in front Refer to chart in manual
- From insert to side wall. 3"
- Mantel 9" deep from top of insert* 16"
- *Mantel must be a minimum of 16" from top of fireplace face. The maximum depth at this height is 9". See additional mantel clearance configurations in the installation manual.

Existing Fireplace Requirements

Jordan Series

- Existing fireplace opening must be at least:
- Height: 20 5/8"
 - Front width: 30 5/16"
 - Width at minimum depth: 24 5/16"
 - Depth: 16"

Jordan XL Series

- Existing fireplace opening must be at least:
- Height: 24 1/2"
 - Front width: 34"
 - Width at minimum depth: 28 3/16"
 - Depth: 16 3/8"

Existing chimney must be at least:

Inside Diameter:

- Factory built solid fuel chimney: 7" minimum
- Masonry chimney: 6" x 8" minimum

Height:

- 10' minimum
- 35' maximum

Vent System Approval & Requirements

These models are approved for use with the following Vent Systems only:

- Kozy Heat™ - #816 venting components
- Simpson Dura-Vent™ - 46DVA-VCH
- Selkirk Metalbestos™ - 4DT-VC
- Ameri-Vent™ - 4DVC
- Metal Fab™ - 4DVT
- ICC™ - TM-IVT TM-SVT
- Security™ - 3PDVCV
- RLH™ - HS-C33U99 HS-C33F1313 HS-CD3333-1313

Vertical Termination ONLY

Minimum vent run: 10' Maximum vent run: 35'

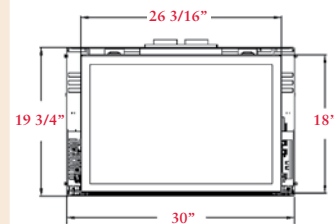

Jordan Series

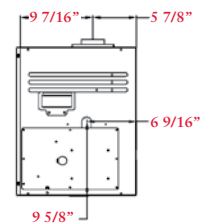

Jordan Series

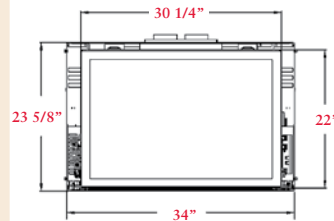

Jordan XL Series

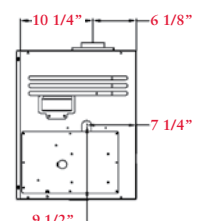

Jordan XL Series

*Features/Options & Specifications are subject to change



Chaska XL w/Black clean face shroud overlay



*Chaska w/
Arched Prairie
pattern full
door shroud*



*Chaska w/Rectangular Prairie
pattern full door shroud*

Tired of coming home to the inconvenience of a wood burning fireplace? Let a Kozy Heat *Chaska* gas insert solve your problems. The *Chaska* gas insert is completely airtight and is the perfect solution to your inefficient wood fireplace. The *Chaska* gas insert offers a large viewing area, realistic logs and flame, and is available in two sizes to fit almost any size of existing opening. With a variety of design and door options, the *Chaska* gas insert will make your fireplace the focal point of your home.

CHASKA SERIES OPTIONS & ACCESSORIES

Three Piece Shrouds/Door Shrouds



Standard three piece shroud



Colonial shroud



Colonial shroud w/three piece magnetic appliques



Drake pattern full door shroud



Arched Drake pattern full door shroud



Arched Prairie pattern full door shroud



Rectangular Prairie pattern full door shroud



Clean face shroud overlay - black

Also available in rust, brushed stainless and titanium. Three or four piece shroud required for installation.



Mission design doors



Mission design doors antique copper



Mission design doors brushed nickel

Finishes



Titanium finish



Rust finish



Brushed stainless finish

Refractories



Brick refractory

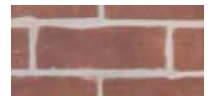

Red brick refractory (optional)

Controls



Wall mount thermostat



Wireless wall mount thermostat



Wireless wall switch



Remote control



IPI full function remote

CHASKA SERIES GAS INSERT SPECIFICATIONS

Model	Fuel Option	High	Low
Chaska	NG	27,500	19,000
Chaska	LP	28,000	20,400
Chaska XL	NG	36,500	22,000
Chaska XL	LP	36,000	22,000

Zone Heat

Install a Kozy Heat furnace rated, high efficient fireplace and save money - lower your fuel bill when you turn your furnace down and heat only the room(s) where you'll be spending time in.

Standard Features

- Efficiency rating: NG - 79% LP - 79% (Chaska)
- Efficiency rating: NG - 75% LP - 80% (Chaska XL)
(Steady state efficiency at high burn, In-House testing)
- **Canada P-4 approved**
- High quality lifetime ceramic glass: 14 1/4" x 29" (Chaska)
- High quality lifetime ceramic glass: 18" x 32" (Chaska XL)
- Refractory brick lining
- Quick-latch glass / pressure relief system
- Co-linear vent system - 3" combustion air / 3" exhaust
- Innovative vent connection system
- Engineer-designed burner system
- Fan kit with variable speed control (2 - 75 CFM)
- Chaska - IPI & Chaska XL - IPI only (electric ignition) - remote modulating valve system w/flame, fan adjustment & fan kit
- Upper grill/hood and lower grill (black) included
- Minnesota Energy Code compliant to 50 pascals

Optional Features

- Full door shroud designs
- Clean face shroud overlay - three or four piece shroud required for install
- Three (3 pc.) standard size shrouds and custom shrouds
- Chaska surrounds available: 25" x 38"; 27 1/2" x 42"; and 30" x 44"
- Chaska XL surrounds available: 27" x 40"; 30" x 44"; and 33" x 46"
- Mission design doors - also available in antique copper and brushed nickel
- Available finishes black, rust, titanium or brushed stainless
- Non-IPI units only: remote control or thermostatic remote control
- Non-IPI units only: wall thermostat / wireless wall mount thermostat
- Red brick refractory

Safety

- **Each unit factory tested!**
- Tested by OMNI-Test Laboratories complies with ANSI-Z21.88a-2007•CSA 2.33a-2007 'Vented Gas Fireplace Heaters'
- U.S. & Canadian installation approved
- Sealed combustion chamber with standing pilot ignition
- Removable millivolt board with 30-second safety pilot
- Automatic pressure relief glass system
- Bedroom & mobile home approved

Minimum Dimensions

Chaska

- | | |
|------------------------------------|---|
| Existing Fireplace Opening: | Existing Chimney: |
| • Height: 19 1/2" | • Class 'A' metal chimney or masonry chimney: 7" I.D. |
| • Width: 31" | • Minimum chimney height: 12' |
| • Depth: 15 1/4" | • Maximum chimney height: 30' |

Chaska XL

- | | |
|------------------------------------|---|
| Existing Fireplace Opening: | Existing Chimney: |
| • Height: 23 1/2" | • Class 'A' metal chimney or masonry chimney: 7" I.D. |
| • Width: 33 1/2" | • Minimum chimney height: 12' |
| • Depth: 16 1/2" | • Maximum chimney height: 35' |

Specifications

Chaska

- Height: 19 1/4"
- Width: 30 7/8"
- Back Width: 23 1/8"
- Depth: 14 1/2"
- Weight: 140 lbs.

Chaska XL

- Height: 23"
- Width: 33 3/8"
- Back Width: 24 3/8"
- Depth: 16"
- Weight: 158 lbs.

Clearances

Chaska

- From insert bottom to combustible floor in front 3 1/2"
- From insert to sidewall 10"
- Insert top to 3/4" trim. 8"
- Mantel 10" deep from top of insert* 13"

Chaska XL

- From insert bottom to combustible floor in front 6"
- From insert bottom underneath to combustible floor 0"
- From insert to sidewall 12"
- Insert top to 3/4" trim. 12"
- Mantel 9" deep from top of insert* 16"

Vent System Approval & Requirements

This fireplace is approved for use with the following co-linear flexible vent systems:

- Simpson Dura-Vent™ DV-GS - 3" x 3"
- Selkirk Metalbestos™ Direct Chimney System - 3" x 3"
- American Metal Products™ Ameri-Vent System - 3" x 3"
- Kozy Heat™ #816 co-linear vent flexible termination kit

*Refer to the installation manual for complete installation & venting requirements.

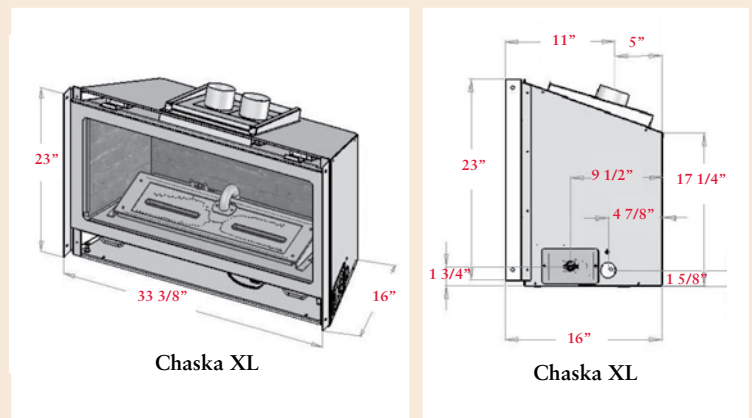
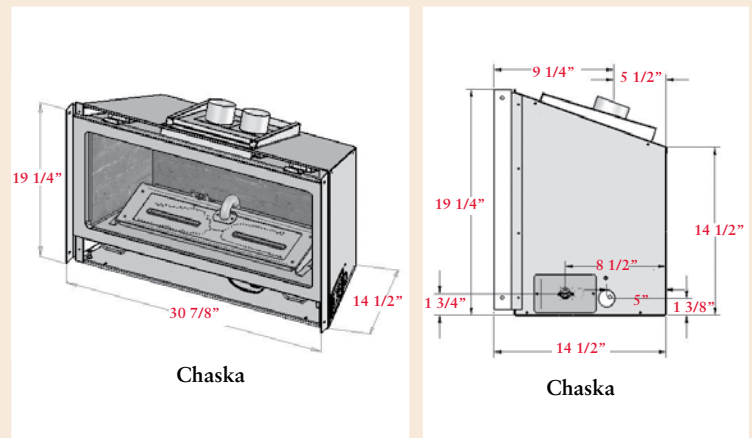

*Features/Options & Specifications are subject to change



Jackson w/black screen doors and black grills



Jackson w/Prairie screen doors and black grills



Jackson XL w/Titanium clean face shroud overlay

Transform that cold, drafty fireplace with a clean efficient *Jackson* gas insert from Kozy Heat. Direct vent gas fireplace inserts are self-contained units designed to be installed within an existing fireplace opening. They can provide more heat than natural gas log sets as a result of controlled combustion and ventilation. With just the flick of a switch you have a warm, safe, fire without the smoke and ashes of wood. So discover the warmth, beauty and convenience of a Kozy Heat gas fireplace insert.

JACKSON SERIES OPTIONS & ACCESSORIES

Full Door Shrouds



Black Renaissance pattern full door shroud

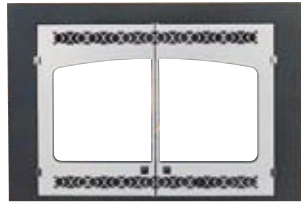

Brushed nickel Renaissance pattern full door shroud

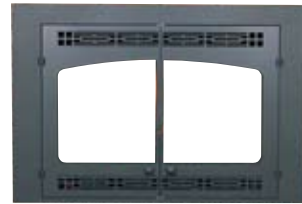

Black Mission design full door shroud

Also available in onyx and antique copper



Black onyx Mission design

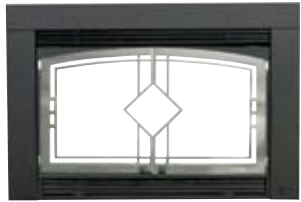

Brushed nickel diamond pattern

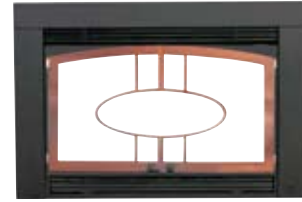

Antique copper oval pattern

The above three doors are available in all finishes, only black contains screen

Three Piece Shrouds/Doors



Black screen doors



Black Prairie screen doors



Moose pattern



Deer w/broken tree pattern



Clean face shroud overlay - black

Also available in rust, brushed stainless and titanium. Three or four piece shroud required for installation.

Finishes



Titanium finish



Rust finish



Brushed stainless finish

Grill Sets



Brass grills



Brass accent grills



Brushed nickel grills



Brushed nickel accent grills



Black grills

Chrome and chrome accent grills not shown

The grills shown above are examples of the different finishes available - the number of louvers per grill varies by model

Trims



Arched valance brass trim



Arched valance chrome trim

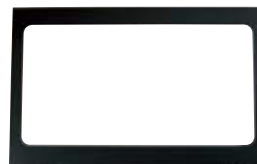

Rectangular valance



Valance screen

Controls



Wall mount thermostat



Wireless wall mount thermostat



Wireless wall switch



Remote control



IPI full function remote

Refractories



Standard brick refractory



Rock refractory (for #XL only)

JACKSON SERIES GAS INSERT SPECIFICATIONS

Model	Fuel Option	High	Low	*Efficiency
Jackson	NG	40,000	27,500	80%
Jackson	NG	33,000	23,000	80%
Jackson	LP	30,000	23,500	81%
Jackson XL	NG	36,000	27,000	80%
Jackson XL	LP	36,000	25,000	81%

Steady state efficiency at high burn.

Standard Features

- High quality borofloat glass
Jackson 12" x 27"
Jackson XL 17" x 30"
- Jackson - IPI & Jackson XL - IPI only (electric ignition) - remote modulating valve system w/flame, fan adjustment & fan kit
- Quick-latch glass with standard arched valance
- Seasonal heat-dump baffle
- Co-linear air duct (manifold)
- Automatic fan (2 – 75 CFM) with variable speed control
- Refractory firebrick panels (back & sides)
- High-low regulator
- Patented burner & log design
- Minnesota energy code compliant to 50 pascals

Optional Features

- Co-linear vent system
 - Co-axial vent system - includes co-axial air duct
 - Grills - several styles/finishes available
 - Arched valance brass or chrome glass trim
 - Rectangular valance (replaces arched valance)
 - Valance screen
 - Non-IPI units only: on/off remote control or thermostatic remote control
 - Non-IPI units only: wall-mount thermostat / wireless wall mount thermostat
 - Decorative (beveled) paneled glass (Jackson XL)
 - Decorative screen doors
 - 3 pc. or 4 pc. shrouds (Masonry or ZC style) with on/off switch mounting hole
 - Clean face shroud overlay - three or four piece shroud required for install
 - Black, brass or chrome shroud trim
 - Custom shrouds (Masonry or ZC style)
 - Available finishes black, rust, titanium or brushed stainless
- NOTE: Custom shroud order form must be completed.

Safety

- Each unit factory tested!
- Tested and complies with ANSI Z21.88b-2008 • CSA 2.33b-2008 'Vented Gas Fireplace Heater'
- Sealed combustion chamber
- Removable millivolt board with 30-second delay
- Safety pilot with piezo standing pilot ignition
- Requires no electricity to operate - excluding fan
- Automatic pressure relief glass system

MINIMUM EXISTING FIREPLACE OPENING DIMENSIONS

Model	Height	Width	Depth	Width at Min. Depth at Location
Jackson	19"	31 1/2"	16 1/2"	21"
Jackson XL	23 1/2"	33 1/2"	16 1/2"	23 1/2"

*Minimum opening width is smaller than the actual fireplace width.

Termination Options

- Co-axial vent system - 40' of 4" x 6" flex pipe with termination cap (Jackson only)
- Extension kit (optional)
- Minimum chimney height - 12'
- Maximum chimney height - 40'
- Co-linear vent system - 25' of 4" and 3" flex pipe with termination cap
- Extension kit (optional)
- Minimum chimney height - 12' - Jackson
11' - Jackson XL & Jackson XXL
- Maximum chimney height - 30' - Jackson
40' - Jackson XL & Jackson XXL

IMPORTANT: Refer to the installation manual for the model you are installing for complete installation and venting requirements.

Co-Axial Air Duct

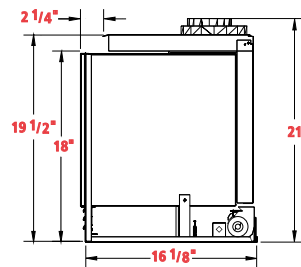

Co-Linear Air Duct

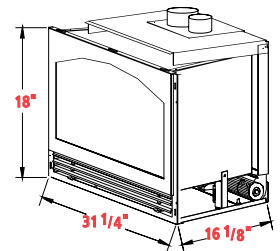

Jackson Model
Weight - 125 lbs.

Co-Linear Air Duct

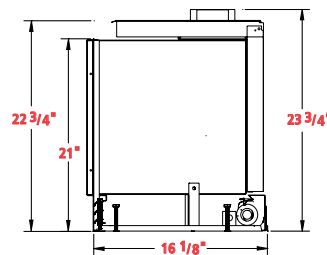

Co-Linear Air Duct

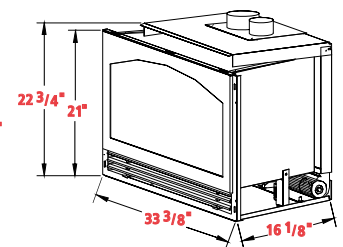

Jackson XL Model
Weight - 135 lbs.

*Features/Options & Specifications are subject to change



For complete information and installation instructions, contact your Kozy Heat Dealer at:

Manufactured by Hussong Mfg. Co. Inc.
204 Industrial Park Drive, Lakefield, MN 56150
Phone 1-800-253-4904 www.kozyheat.com

In order to continually provide the highest quality product available, specifications and dimensions are subject to change. Refer to the unit installation manual for complete installation instructions. Installation must conform with local building codes.